

Features

Multi-function and mono-function timer range

80.01 - Multi-function & multi-voltage

80.11 - ON delay, multi-voltage

- 17.5 mm wide
- Six time scales from 0.1 s to 24h
- High input/output isolation
- 35 mm rail (EN 60715) mount
- "Blade + cross" - both flat blade and cross head screw drivers can be used to adjust the range and function selectors, the timing trimmer, and to disengage the rail mounting clip
- New multi-voltage versions with "PWM clever" technology

80.01 / 80.11
Screw terminal

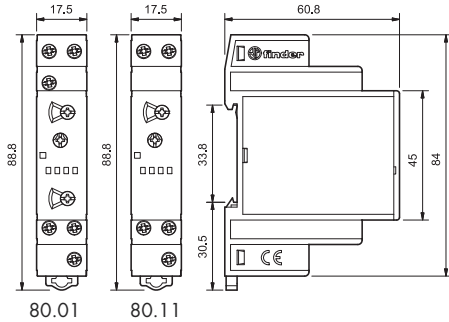

FOR UL HORSEPOWER AND PILOT DUTY RATINGS
SEE "General technical information" page V

80.01



- Multi-voltage
- Multi-function

AI: ON delay
DI: ON pulse
SW: Symmetrical recycling: ON start
BE: Signal OFF delay
CE: Signal ON and OFF delay
DE: Signal ON pulse

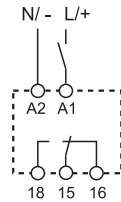

Wiring diagram
(without signal START)

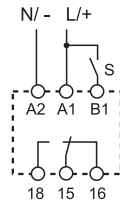

Wiring diagram
(with signal START)

80.11



- Multi-voltage
- Mono-function

AI: ON delay

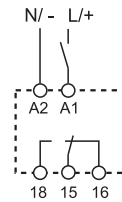

Wiring diagram
(without signal START)

Contact specification

Contact configuration		1 CO (SPDT)	1 CO (SPDT)
Rated current/Maximum peak current	A	16/30	16/30
Rated voltage/Maximum switching voltage V AC		250/400	250/400
Rated load AC1	VA	4,000	4,000
Rated load AC15 (230 V AC)	VA	750	750
Single phase motor rating (230 V AC)	kW	0.55	0.55
Breaking capacity DC1: 30/110/220 V	A	16/0.3/0.12	16/0.3/0.12
Minimum switching load	mW (V/mA)	500 (10/5)	500 (10/5)
Standard contact material		AgCdO	AgCdO

Supply specification

Nominal voltage (U _N)	V AC (50/60 Hz)	12...240	24...240
	V DC	12...240	24...240
Rated power AC/DC	VA (50 Hz)/W	< 1.8 / < 1	< 1.8 / < 1
Operating range	AC	(10.8...265)V	(17...265)V
	DC	(10.8...265)V	(17...265)V

Technical data

Specified time range		(0.1...2)s, (1...20)s, (0.1...2)min, (1...20)min, (0.1...2)h, (1...24)h	
Repeatability	%	± 1	± 1
Recovery time	ms	≤ 50	≤ 50
Minimum control impulse	ms	50	—
Setting accuracy-full range	%	± 5	± 5
Electrical life at rated load in AC1	cycles	100·10 ³	100·10 ³
Ambient temperature range	°C	-10...+50	-10...+50
Protection category		IP 20	IP 20

Approvals (according to type)

Features

Mono-function timer range

80.21 - ON pulse, multi-voltage

80.41 - Signal OFF delay, multi-voltage

80.91 - Asymmetrical recycling, multi-voltage

- 17.5 mm wide
- Six time scales from 0.1s to 24h
- High input/output isolation
- 35 mm rail (EN 60715) mount
- "Blade + cross" - both flat blade and cross head screw drivers can be used to adjust the range and function selectors, the timing trimmer, and to disengage the rail mounting clip
- New multi-voltage versions with "PWM clever" technology

80.21 / 80.41 / 80.91
Screw terminal

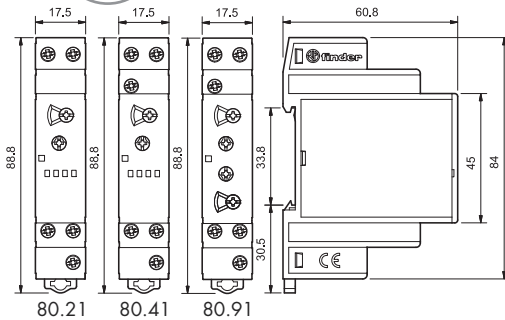

FOR UL HORSEPOWER AND PILOT DUTY RATINGS
SEE "General technical information" page V

	80.21	80.41	80.91
	<ul style="list-style-type: none"> • Multi-voltage • Mono-function 	<ul style="list-style-type: none"> • Multi-voltage • Mono-function 	<ul style="list-style-type: none"> • Multi-voltage • Mono-function
	DI: ON pulse	BE: Signal OFF delay	LI: Asymmetrical recycling (ON starting) LE: Signal asymmetrical recycling (ON starting)
	<p>Wiring diagram (without signal START)</p>	<p>Wiring diagram (with signal START)</p>	<p>Wiring diagram (without signal START) Wiring diagram (with signal START)</p>
	Contact specification		
Contact configuration	1 CO (SPDT)		
Rated current/Maximum peak current A	16/30		
Rated voltage/Maximum switching voltage V AC	250/400		
Rated load AC1 VA	4,000		
Rated load AC15 (230 V AC) VA	750		
Single phase motor rating (230 V AC) kW	0.55		
Breaking capacity DC1: 30/110/220 V A	16/0.3/0.12		
Minimum switching load mW (V/mA)	500 (10/5)		
Standard contact material	AgCdO		
Supply specification			
Nominal voltage (U _N)	V AC (50/60 Hz)	24...240	24...240
	V DC	24...240	24...240
Rated power AC/DC VA (50 Hz)/W	< 1.8 / < 1	< 1.8 / < 1	< 1.8 / < 1
Operating range	AC	(17...265)V	(17...265)V
	DC	(17...265)V	(17...265)V
Technical data			
Specified time range	(0.1...2)s, (1...20)s, (0.1...2)min, (1...20)min, (0.1...2)h, (1...24)h		
Repeatability %	± 1		
Recovery time ms	≤ 50		
Minimum control impulse ms	—		
Setting accuracy-full range %	± 5		
Electrical life at rated load in AC1 cycles	100·10 ³		
Ambient temperature range °C	-10...+50		
Protection category	IP 20		
Approvals (according to type)			

Features

Multi-function and multi-voltage solid-state output timer

- 17.5 mm wide
- Six time scales from 0.1 s to 24h
- High input/output isolation
- 35 mm rail (EN 60715) mount
- Multi-voltage output (24...240 V AC/DC), independent from the input voltage
- "Blade + cross" - both flat blade and cross head screw drivers can be used to adjust the range and function selectors, the timing trimmer, and to disengage the rail mounting clip
- Multi-voltage input with "PWM clever" technology

80.71
Screw terminal

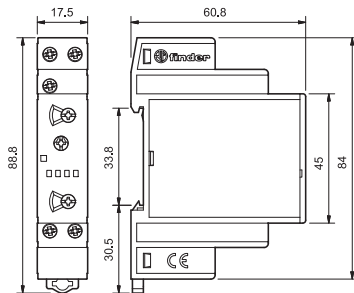

80.71



- Multi-voltage
- Multi-function

- AI:** ON delay
DI: ON pulse
SW: Symmetrical recycling: ON start
BE: Signal OFF delay
CE: Signal ON and OFF delay
DE: Signal ON pulse

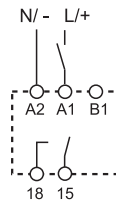

Wiring diagram
(without signal START)

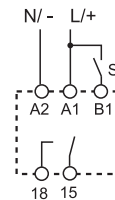

Wiring diagram
(with signal START)

Output circuit		
Contact configuration		1 NO (SPST-NO)
Rated current	A	1
Rated voltage	V AC/DC	24...240
Switching voltage range	V AC/DC	19...265
Rated load AC15	A	1
Rated load DC1	A	1
Minimum switching current	mA	0.5
Max. "OFF-state" leakage current	mA	0.05
Max. "ON-state" voltage drop	V	2.8
Input circuit		
Nominal voltage (U _N)	V AC (50/60 Hz)	24...240
	V DC	24...240
Rated power	VA (50 Hz)/W	1.3/1.3
Operating range	AC	(19...265)V
	DC	(19...265)V
Technical data		
Specified time range		(0.1...2)s, (1...20)s, (0.1...2)min, (1...20)min, (0.1...2)h, (1...24)h
Repeatability	%	± 1
Recovery time	ms	≤ 50
Minimum control impulse	ms	50
Setting accuracy-full range	%	± 5
Electrical life	cycles	100·10 ⁶
Ambient temperature range	°C	-20...+50
Protection category		IP 20
Approvals (according to type)		

Features

Mono-function timer range

80.61 - True OFF delay, multi-voltage

80.82 - Star-Delta timer, multi-voltage

- 17.5 mm wide
- Rotary range selector, and timing trimmer
- Four time scales from 0.1s to 20s (type 80.61)
- Six time scales from 0.1s to 20min (type 80.82)
- High input/output isolation
- 35 mm rail (EN 60715) mount

80.61 / 80.82
Screw terminal

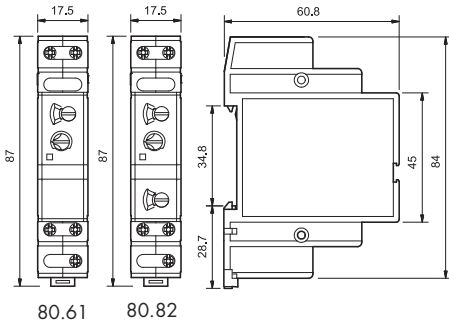

FOR UL HORSEPOWER AND PILOT DUTY RATINGS
SEE "General technical information" page V

Contact specification

Contact configuration		1 CO (SPDT)	2 NO (DPST-NO)
Rated current/Maximum peak current	A	8/15	6/10
Rated voltage/Maximum switching voltage	V AC	250/400	250/400
Rated load AC1	VA	2,000	1,500
Rated load AC15 (230 V AC)	VA	400	300
Single phase motor rating (230 V AC)	kW	0.3	—
Breaking capacity DC1: 30/110/220 V	A	8/0.3/0.12	6/0.2/0.12
Minimum switching load	mW (V/mA)	300 (5/5)	500 (12/10)
Standard contact material		AgNi	AgNi

Supply specification

Nominal voltage (U _N)	V AC (50/60 Hz)	24...240	12...240
	V DC	24...240	12...240
Rated power AC/DC	VA (50 Hz)/W	< 0.6/ < 0.6	< 1.3/ < 0.8
Operating range	AC	(17...265)V	(10.2...265)V
	DC	(17...265)V	(10.2...265)V

Technical data

Specified time range		(0.1...1)s, (0.5...5)s, (1...10)s, (2...20)s	(0.1...2)s, (1...20)s, (0.1...2)min, (1...20)min
Repeatability	%	± 1	± 1
Recovery time	ms	≤ 50	≤ 50
Minimum control impulse	ms	300 (A1-A2)	—
Setting accuracy-full range	%	± 5	± 5
Electrical life at rated load in AC1	cycles	100·10 ³	60·10 ³
Ambient temperature range	°C	-10...+50	-10...+50
Protection category		IP 20	IP 20

Approvals (according to type)



Ordering information

Example: 80 series, modular timers, 1 CO (SPDT) - 16 A, supply rated at (12...240)V AC/DC.

8 0 . 0 1 . 0 2 4 0 . 0 0 0 0

Series

Type

- 0 = Multi-function (AI, DI, SW, BE, CE, DE)
- 1 = ON delay (AI)
- 2 = ON pulse (DI)
- 4 = Signal OFF delay (BE)
- 6 = True OFF delay (BI)
- 7 = Multi-function with solid state output (AI, DI, SW, BE, CE, DE)
- 8 = Star-Delta (SD)
- 9 = Asymmetrical recycling ON starting (LI, LE)

Versions

- 0 = Standard
- 2 = Standard (for type 80.61 only)

Supply voltage

- 240 = (12 ... 240)V AC/DC (80.01, 80.82, 80.91)
- 240 = (24 ... 240)V AC/DC (80.11, 80.21, 80.41, 80.61, 80.71)

Supply version

- 0 = AC (50/60 Hz)/DC

No. of poles

- 1 = 1 CO (SPDT)
- 1 = 1 NO (SPST-NO), type 80.71 only
- 2 = 2 NO (DPST-NO), type 80.82 only

Technical data

Insulation			
Dielectric strength			80.01/11/21/41/82/91
	between input and output circuit	V AC	4,000
	between open contacts	V AC	1,000
Insulation (1.2/50 µs) between input and output		kV	6
80.61/71			
between input and output circuit			2,500
between open contacts			1,000
Insulation (1.2/50 µs) between input and output		kV	4
EMC specifications			
Type of test		Reference standard	
Electrostatic discharge	contact discharge	EN 61000-4-2	4 kV
	air discharge	EN 61000-4-2	8 kV
Radio-frequency electromagnetic field (80 ÷ 1000 MHz)		EN 61000-4-3	10 V/m
Fast transients (burst) (5-50 ns, 5 kHz) on Supply terminals		EN 61000-4-4	4 kV
Surges (1.2/50 µs) on Supply terminals	common mode	EN 61000-4-5	4 kV
	differential mode	EN 61000-4-5	4 kV
	on start terminal (B1) common mode	EN 61000-4-5	4 kV
	on start terminal (B1) differential mode	EN 61000-4-5	4 kV
Radio-frequency common mode (0.15 ÷ 80 MHz) on Supply terminals		EN 61000-4-6	10 V
Radiated and conducted emission		EN 55022	class B
Other data			
Current absorption on signal control (B1)			< 1 mA
Power lost to the environment	without contact current	W	1.4
	with rated current	W	3.2
Screw torque		Nm	0.8
Max. wire size		solid cable	stranded cable
		mm ²	1x6 / 2x4
		AWG	1x10 / 2x12

Accessories



020.24

Sheet of marker tags, for types 80.61/82, plastic, 24 tags, 9x17 mm

020.24

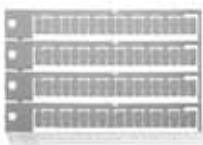

060.72

Sheet of marker tags, for types 80.01/11/21/41/71, plastic, 72 tags, 6x12 mm





060.72

Functions

U = Supply voltage

S = Signal switch

 = Output contact

LED*	Supply voltage	NO output contact	Contacts	
			Open	Closed
	OFF	Open	15 - 18	15 - 16
	ON	Open	15 - 18	15 - 16
	ON	Open (Timing in Progress)	15 - 18	15 - 16
	ON	Closed	15 - 16	15 - 18

* The LED on type 80.61 is illuminated only when the supply voltage is applied to the timer; during the timing period the LED is not illuminated.

Wiring diagram

Without signal Start = Start via contact in supply line (A1).
 With signal Start = Start via contact into control terminal (B1).

Without signal START

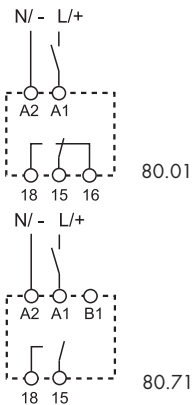

Type 80.01 80.71

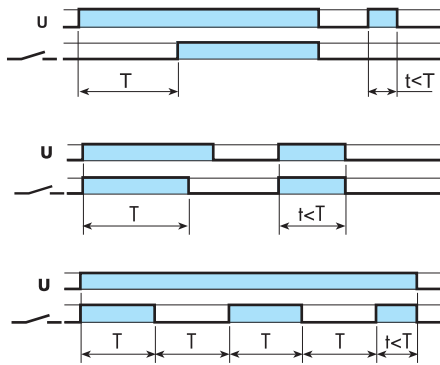

(AI) ON delay.
Apply power to timer. Output contacts transfer after preset time has elapsed. Reset occurs when power is removed.

(DI) ON pulse.
Apply power to timer. Output contacts transfer immediately. After the preset time has elapsed, contacts reset.

(SW) Symmetrical recycling: ON start.
Apply power to timer. Output contacts transfer immediately and cycle between ON and OFF for as long as power is applied. The ratio is 1:1 (time on = time off).

With signal START

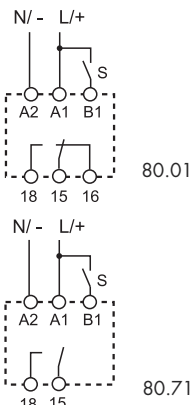

80.01 80.71

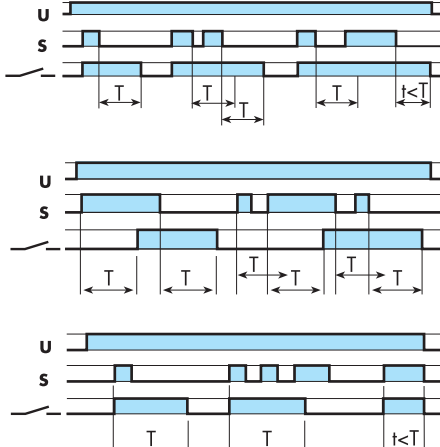

(BE) Signal OFF delay.
Power is permanently applied to the timer. The output contacts transfer immediately on closure of the Signal Switch (S). Opening the Signal Switch initiates the preset delay, after which time the output contacts reset.

(CE) Signal ON and OFF delay.
Power is permanently applied to the timer. Closing the Signal Switch (S) initiates the preset delay, after which time the output contacts transfer. Opening the Signal switch initiates the same preset delay, after which time the output contacts reset.

(DE) Signal ON pulse.
Power is permanently applied to the timer. On momentary or maintained closure of Signal Switch (S), the output contacts transfer, and remain so for the duration of the preset delay, after which they reset.

NOTE: The function must be set before energising the timer.

- Possible to control an external load, such as another relay coil or timer, connected to the signal start terminal B1.

* With DC supply, positive polarity has to be connected to B1 terminal (according to EN 60204-1).

** A voltage other than the supply voltage can be applied to the command Start (B1), example:
 A1 - A2 = 230 V AC
 B1 - A2 = 12 V DC

Functions

Wiring diagram

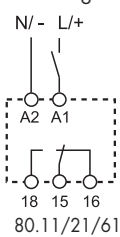
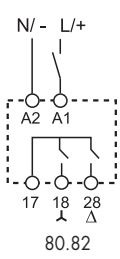
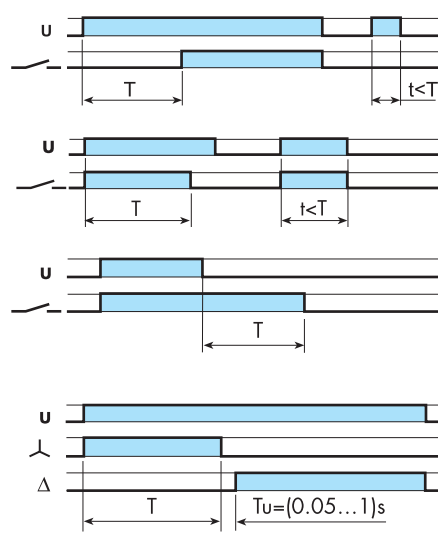
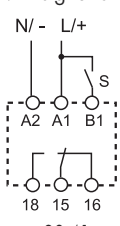
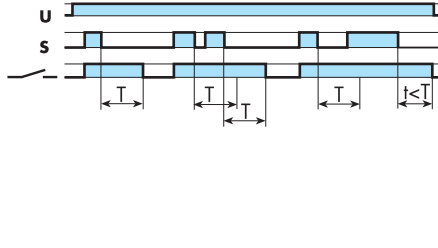
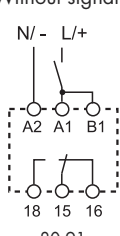
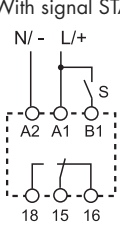
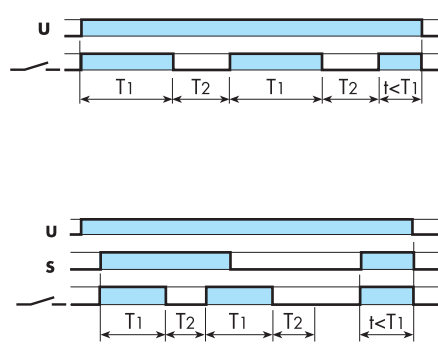
<p>Without signal START</p>  <p>80.11/21/61</p>  <p>80.82</p>	<p>Type 80.11 80.21 80.61 80.82</p>		<p>(AI) ON delay. Apply power to timer. Output contacts transfer after preset time has elapsed. Reset occurs when power is removed.</p> <p>(DI) ON pulse. Apply power to timer. Output contacts transfer immediately. After the preset time has elapsed, contacts reset.</p> <p>(BI) True OFF delay (power OFF). Apply power to timer (minimum 300ms). Output contacts transfer immediately. Removal of power initiates the preset delay, after which time the output contacts reset.</p> <p>(SD) Star - delta. Apply power to timer. The star contact (Λ) closes immediately. After preset delay has elapsed the star contact (Λ) resets. After a further transfer time variable from (0.05...1)s the delta contact (Δ) closes and remains in that position, until reset on power off.</p>
<p>With signal START</p>  <p>80.41</p>	<p>80.41</p>		<p>(BE) Signal OFF delay. Power is permanently applied to the timer. The output contacts transfer immediately on closure of the Signal Switch (S). Opening the Signal Switch initiates the preset delay, after which time the output contacts reset.</p>
<p>Without signal START</p>  <p>80.91</p> <p>With signal START</p>  <p>80.91</p>	<p>80.91</p>		<p>(LI) Asymmetrical recycling (ON start). Apply power to timer. Output contacts transfer immediately and cycle between ON and OFF for as long as power is applied. The ON (T1) and OFF (T2) times are independently adjustable.</p> <p>(LE) Signal asymmetrical recycling (ON start) Power is permanently applied to the timer. Closing Signal Switch (S) causes the output contacts to transfer immediately and cycle between ON (T1) and OFF (T2), until opened.</p>

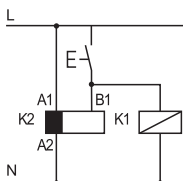

- Possible to control an external load, such as another relay coil or timer, connected to the signal start terminal B1.

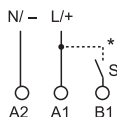

- * With DC supply, positive polarity has to be connected to B1 terminal (according to EN 60204-1).

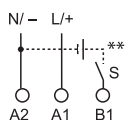

- ** A voltage other than the supply voltage can be applied to the command Start (B1), example:
A1 - A2 = 230 V AC
B1 - A2 = 12 V DC